

Torque Motor

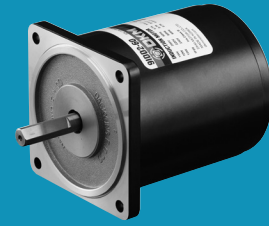

Torque Motor

Index

Outline of Torque Motor	B-163
Torque Motor 6W (□70mm)	B-165
Torque Motor 10W (□80mm)	B-167
Torque Motor 20W (□90mm)	B-169
Torque Motor 30W (□90mm)	B-171
Torque Motor 40W (□90mm)	B-173

B AC Motors

Outline of Torque Motor

Features

Torque motors are designed for providing high torque and sloping characteristics. (Torque is highest at zero speed and decreases steadily as speed increases.)

● Various Speed over a Wide Range

The torque is approximately in proportion to the square of the voltage. Easy speed control is available by changing the voltage of the power supply.

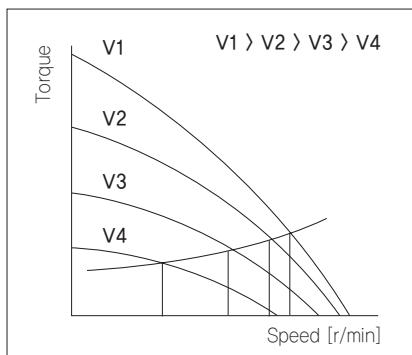

● Locked Operation

Torque motors are designed to provide stable torque even under stall conditions or at very low speeds (nearly stop). It is available only in torque motors not in induction or reversible motors. They are suitable for pushing applications that require static torque, or for loads that are usually under a locked rotor condition and are under stall conditions at the end of processes. At 60VAC or less the continuous operation is possible but when it is used at voltages above 60VAC, the motors are rated for limited duty. The motor has a about 5-minute rating at 115VAC or 220 VAC.

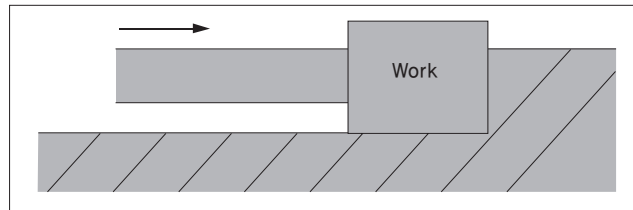

***Note:** When using a motor in locked rotor condition, the output torque becomes very large. The output torque of the Gearbox must be lower than the maximum permissible torque. Also ensure that the load does not hit an object and stop, since this can cause damage to the Gearbox due to the shock.

● Use as a Brake

By using the motor in the braking region of the speed-torque characteristics, it can serve as a brake. Constant tension control can be achieved by applying a DC voltage.

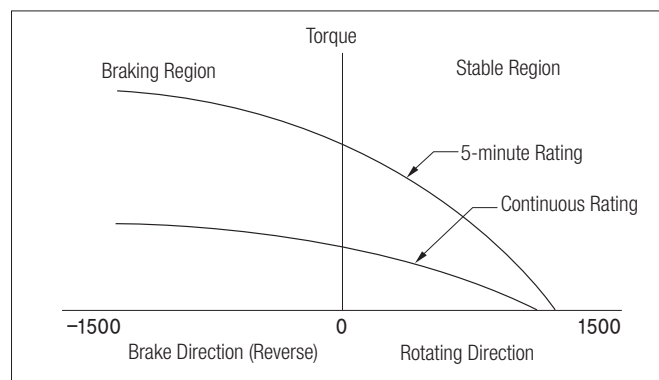
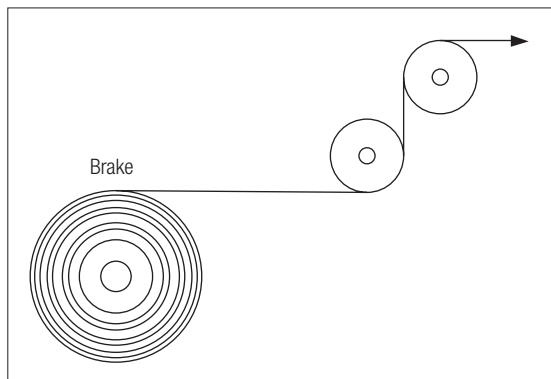

● Suitable for Winding Applications

In an application where an object is released continuously at a constant speed and wound up with constant tension, the torque must be doubled and the speed must be halved if the diameter of the winding spool is doubled.

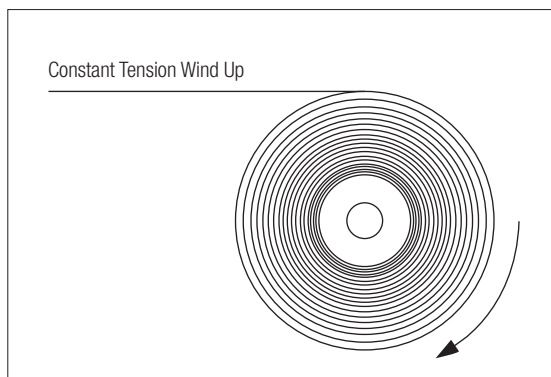

Speed-Torque Characteristics

- The torque of torque motor is approximately in proportion to the square of the voltage. When the voltage supplied to the motor is changed, speed-torque curves with sloping characteristics (torque is highest at zero speed and decreases steadily as speed increases) will be corresponding voltage. If the voltage is changed to 115VAC, 80VAC and 60VAC while the load torque is T_0 , the motor rotates at the speeds N_1 , N_2 and N_3 respectively. That is to say, the speed can be changed easily by varying the voltage. In choosing a torque motor, first determine the required torque and speed and then select a motor using the speed-torque characteristics curves to determine whether the motors should be operated under continuous duty or limited duty. In using motor under locked rotor conditions, only the torque factor is considered.

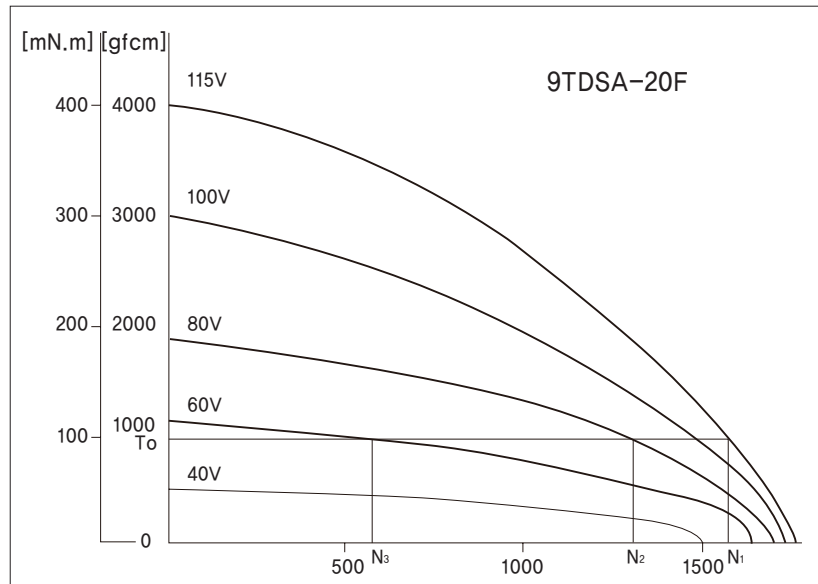

Voltage Control of Torque Motor

- As shown in the graph, as the phase angle "alpha" at which the triac switches changes, the input voltage is controlled as represented by the phase angle areas of the graph. When changing the speed or the torque, an external voltage controller is needed.

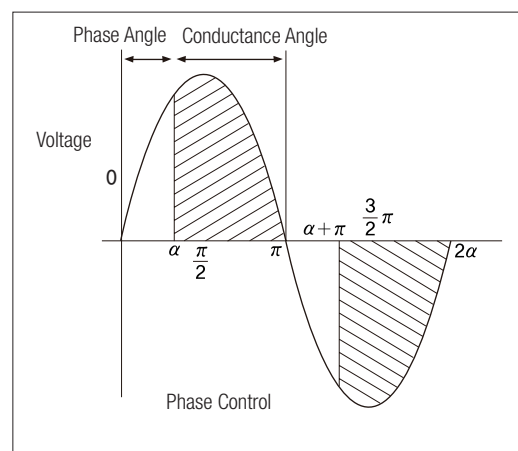

General Specifications

Item	Specification
Insulation Resistance	100M Ω or more when DC500V MEGA is applied between the windings and the frame after rated motor operation under normal ambient temperature and humidity.
Dielectric Strength	Sufficient to withstand 1.5KV at 50Hz and 60Hz applied between the windings and the frame for 1 minute after rated motor operation under normal ambient temperature and humidity.
Temperature Rise	Temperature rise of windings are 80 $^{\circ}$ C or less measured by the resistance change method after rated motor operation with connecting a Gearbox or equivalent heat radiation plate.
Insulation Class	Class B [130 $^{\circ}$ C]
Overheat Protection	Operating temperature (Built-in thermal protector type motor): Open 120 $^{\circ}$ C \pm 5 $^{\circ}$ C, Close 90 $^{\circ}$ C \pm 5 $^{\circ}$ C
Ambient Temperature	-10 $^{\circ}$ C \sim +40 $^{\circ}$ C (Three phase 220VAC: -10 $^{\circ}$ C \sim +50 $^{\circ}$ C)
Ambient Humidity	85% maximum

Connection Diagrams

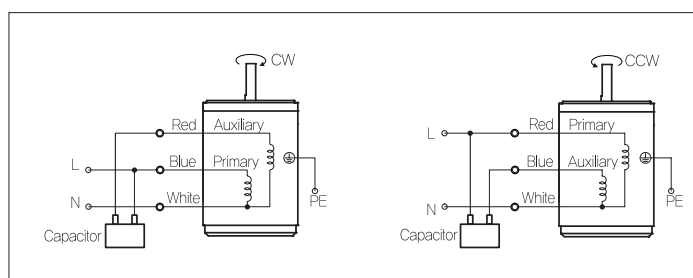

B AC Motors

Torque Motor 6W(□70mm)

6W Torque Motor 6W(□70mm)

Motor Specification

Model 7TDG□-6G: Gear Type Shaft 7TDD□-6: D-Cut Type Shaft	Rating at Locked Rotor	Voltage V	Frequency Hz	Poles	Starting Torque		Output Hz	At max. Output Power				Capacitor μF / VAC	
					kgfcm	N.m		Speed r/min	Torque kgfcm N.m	Current A	Input W		
7TDGA-6G	5min.	1∅ 110	60	4	1.20	0.120	8	900	0.70	0.070	0.60	57	10.0 / 250
	Cont.	1∅ 60			0.42	0.042	2.5		0.23	0.023	0.21	17	
7TDGD-6G	5min.	1∅ 220	60	4	1.20	0.120	8		0.70	0.070	0.18	57	1.5 / 450
	Cont.	1∅ 140			0.42	0.042	2.5		0.23	0.023	0.09	17	
7TDGE-6G	5min.	1∅ 220~240	50	4	1.40	0.140	6	750	0.80	0.080	0.18	55	1.5 / 450
	Cont.	1∅ 140			0.54	0.054	2.3		0.30	0.030	0.09	19	

- 1) Enter the phase & voltage code in the in the box (□) within the motor model name.
- 2) All models contain a built-in thermal protector.
- 3) Gear Type Shaft is for attaching Gearbox and D-Cut Type Shaft is for using motor only.

Max. Permissible Torque at Output Shaft of Gearbox

60Hz

Motor Model	Gearbox Model	Gear Ratio	3	3.6	6	7.5	9	12.5	15	18	25	30	36	50	60	75	90	100	120	150	180	
7TDG□-6G	7GBK□BMH	5min.	kgfcm	1.7	2.1	3.5	4.4	5.2	7.3	8.7	10.5	13.1	15.8	17.1	23.8	28.6	35.7	42.8	47.6	50.0	50.0	50.0
		N.m	0.17	0.20	0.34	0.43	0.51	0.71	0.85	1.02	1.29	1.54	1.68	2.33	2.80	3.50	4.20	4.66	4.90	4.90	4.90	
		Cont.	kgfcm	0.6	0.7	1.1	1.4	1.7	2.4	2.9	3.4	4.3	5.2	5.6	7.8	9.4	11.7	14.1	15.6	18.8	23.5	28.2
		N.m	0.06	0.07	0.11	0.14	0.17	0.23	0.28	0.34	0.42	0.51	0.55	0.77	0.92	1.15	1.38	1.53	1.84	2.30	2.76	

50Hz

Motor Model	Gearbox Model	Gear Ratio	3	3.6	6	7.5	9	12.5	15	18	25	30	36	50	60	75	90	100	120	150	180	
7TDG□-6G	7GBK□BMH	5min.	kgfcm	2.0	2.4	4.0	5.0	6.0	8.3	10.0	12.0	15.0	18.0	19.6	27.2	32.6	40.8	49.0	50.0	50.0	50.0	50.0
		N.m	0.20	0.23	0.39	0.49	0.59	0.81	0.98	1.17	1.47	1.76	1.92	2.67	3.20	4.00	4.80	4.90	4.90	4.90		
		Cont.	kgfcm	0.7	0.9	1.5	1.9	2.2	3.1	3.7	4.5	5.6	6.8	7.3	10.2	12.2	15.3	18.4	20.4	24.5	30.6	36.7
		N.m	0.07	0.09	0.15	0.18	0.22	0.31	0.37	0.44	0.55	0.66	0.72	1.00	1.20	1.50	1.80	2.00	2.40	3.00	3.60	

- 1) Enter the phase & voltage code in the box (□) within the motor model name.
- 2) Enter the gear ratio in the box (□) within the Gearbox model name.
- 3) A colored background indicates gear shaft rotation in the same direction as the motor shaft; a white background indicates rotation in the opposite direction.
- 4) The rotating speed is calculated by dividing the motor's synchronous speed (50Hz: 1,500r/min, 60Hz: 1,800r/min) by the gear ratio.
The actual speed is 2~20% less than the displayed value, depending on the size of the load.

Dimensions

MOTOR ONLY

- MOTOR MODEL: 7TDD□-6 (NO FAN)

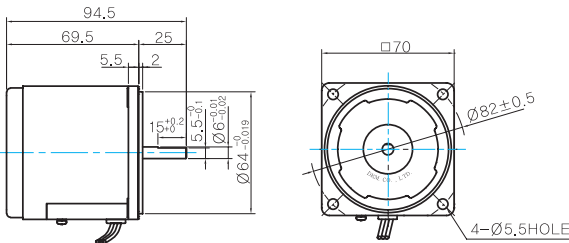

LEAD WIRE 300mm
UL STYLE NO,3266 AWG NO,20

MOTOR OUTPUT SHAFT

MODEL	SPEC
D-CUT TYPE	

GEARED MOTOR

G TYPE GEARBOX

- MOTOR MODEL:
7TDG□-6G (NO FAN)

- GEARBOX MODEL:
7GBK□BMH

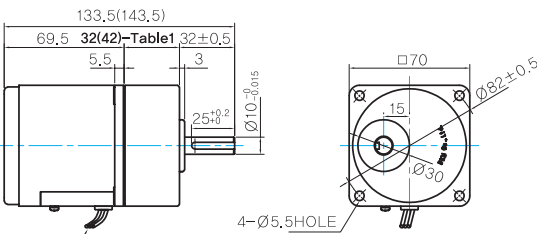

LEAD WIRE 300mm
UL STYLE NO,3266 AWG NO,20

GEARBOX OUTPUT SHAFT

MODEL	SPEC
KEY TYPE	

KEY SPEC

GEARBOX	SIZE

WEIGHT

PART	WEIGHT(Kg)	
MOTOR	0,94	
GEAR BOX	7GBK3BMH - 7GBK18BMH	0,36
	7GBK25BMH - 7GBK30BMH	0,44
	7GBK36BMH - 7GBK180BMH	0,5

32(42)-Table1

SIZE(mm)	GEAR RATIO
32	7GBK3BMH - 7GBK18BMH
42	7GBK25BMH - 7GBK180BMH

Motor Images

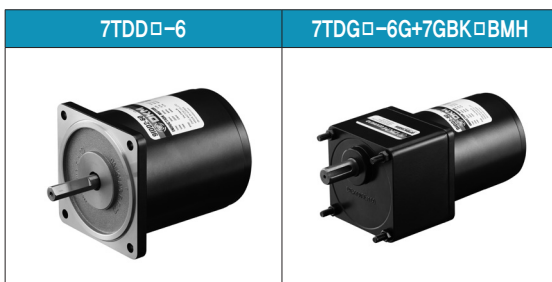

Connection Diagrams

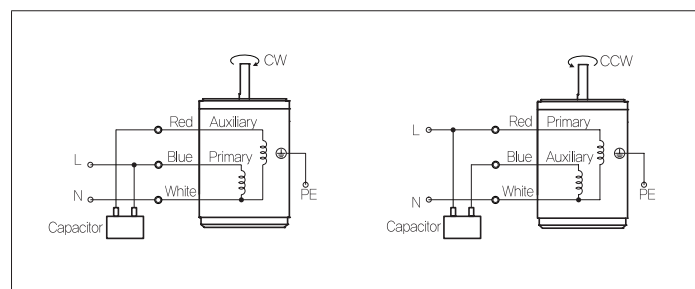

- The direction of motor rotation is as viewed from the shaft end of the motor.
- CW represents the clockwise direction, while CCW represents the counterclockwise direction.
- Change the direction of single phase motor rotation only after bringing the motor to a stop. If an attempt is made to change the direction of rotation while the motor is rotating, the motor may ignore the reversing command or change its direction after some delay.

B AC Motors

Torque Motor 10W(□80mm)

10W

 Torque Motor
10W(□80mm)

Motor Specification

Model 8TDG□-10G: Gear Type Shaft 8TDD□-10: D-Cut Type Shaft	Rating at Locked Rotor	Voltage V	Frequency Hz	Poles	Starting Torque		Output Hz	At max. Output Power				Capacitor μF / VAC	
					kgfcm	N.m		Speed r/min	Torque kgfcm	N.m	Current A		Input W
8TDGA-10G	5min.	1∅ 110	60	4	2.10	0.200	12	900	1.00	0.010	0.80	67	10.0 / 250
	Cont.	1∅ 60			0.70	0.070	3.5		0.38	0.038	0.50	19	
8TDGD-10G	5min.	1∅ 220	60	4	2.20	0.220	10	900	1.00	0.010	0.40	67	2.0 / 450
	Cont.	1∅ 140			0.75	0.075	3.5		0.38	0.038	0.25	19	
8TDGE-10G	5min.	1∅ 220~240	50	4	2.30	0.023	12	750	1.30	0.013	0.40	63	2.0 / 450
	Cont.	1∅ 140			0.75	0.075	3.5		0.46	0.046	0.25	24	

- 1) Enter the phase & voltage code in the box (□) within the motor model name.
- 2) All models contain a built-in thermal protector.
- 3) Gear Type Shaft is for attaching Gearbox and D-Cut Type Shaft is for using motor only.

Max. Permissible Torque at Output Shaft of Gearbox

60Hz

Motor Model	Gearbox Model	Gear Ratio	3	3.6	5	6	7.5	9	12.5	15	18	25	30	36	40	50	60	75	90	100	120	150	180	200	250	300	360	
8TDG□ -10G	8GBK□ BMH	5min.	kgfcm	2.5	3.0	4.2	5.0	6.2	7.5	10.4	12.5	14.9	18.8	22.5	24.5	27.2	34.0	40.8	50.0	50.0	50.0	50.0	50.0	50.0	50.0	50.0	50.0	50.0
		N.m	0.24	0.29	0.41	0.49	0.61	0.73	1.02	1.22	1.46	1.84	2.21	2.40	2.67	3.33	4.00	4.90	4.90	4.90	4.90	4.90	4.90	4.90	4.90	4.90	4.90	4.90
		Cont.	kgfcm	0.9	1.1	1.6	1.9	2.4	2.8	3.9	4.7	5.7	7.1	8.6	11.4	12.6	15.8	18.9	23.7	28.4	31.5	37.8	47.3	50.0	50.0	50.0	50.0	50.0
		N.m	0.09	0.11	0.15	0.19	0.23	0.28	0.39	0.46	0.56	0.70	0.84	1.11	1.24	1.55	1.85	2.32	2.78	3.09	3.71	4.64	4.90	4.90	4.90	4.90	4.90	

50Hz

Motor Model	Gearbox Model	Gear Ratio	3	3.6	5	6	7.5	9	12.5	15	18	25	30	36	40	50	60	75	90	100	120	150	180	200	250	300	360	
8TDG□ -10G	8GBK□ BMH	5min.	kgfcm	3.2	3.9	5.4	6.5	8.1	9.7	13.5	16.2	19.4	24.4	29.3	31.8	35.4	44.2	50.0	50.0	50.0	50.0	50.0	50.0	50.0	50.0	50.0	50.0	50.0
		N.m	0.32	0.38	0.53	0.63	0.79	0.95	1.32	1.59	1.90	2.39	2.87	3.12	3.47	4.33	4.90	4.90	4.90	4.90	4.90	4.90	4.90	4.90	4.90	4.90	4.90	4.90
		Cont.	kgfcm	1.1	1.4	1.9	2.3	2.9	3.4	4.8	5.7	6.9	8.6	10.4	11.3	12.5	15.6	18.8	23.5	28.2	31.3	37.5	46.9	50.0	50.0	50.0	50.0	50.0
		N.m	0.11	0.13	0.19	0.22	0.28	0.34	0.47	0.56	0.67	0.85	1.01	1.10	1.23	1.53	1.84	2.30	2.76	3.07	3.68	4.60	4.90	4.90	4.90	4.90	4.90	

- 1) Enter the phase & voltage code in the box (□) within the motor model name.
- 2) Enter the gear ratio in the box (□) within the Gearbox model name.
- 3) A colored background indicates gear shaft rotation in the same direction as the motor shaft; a white background indicates rotation in the opposite direction.
- 4) The rotating speed is calculated by dividing the motor's synchronous speed (50Hz: 1,500r/min, 60Hz: 1,800r/min) by the gear ratio.
The actual speed is 2~20% less than the displayed value, depending on the size of the load.

Dimensions

MOTOR ONLY

- MOTOR MODEL: 8TDD□-10 (NO FAN)

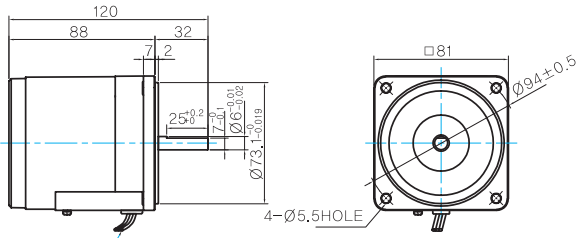

LEAD WIRE 300mm
UL STYLE NO.3271 AWG NO.22

MOTOR OUTPUT SHAFT

MODEL	SPEC
D-CUT TYPE	

INTER-DECIMAL GEARBOX

- MODEL: 8XD10□□

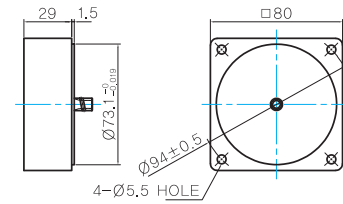

GEARED MOTOR

G TYPE GEARBOX

- MOTOR MODEL: 8TDG□-10G (NO FAN)

- GEARBOX MODEL: 8GBK□BMH

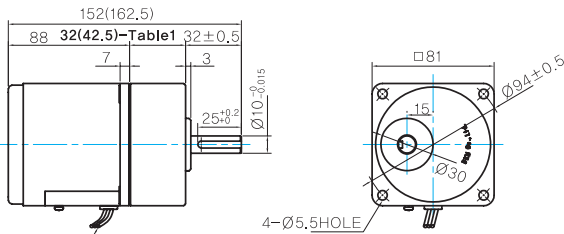

LEAD WIRE 300mm
UL STYLE NO.3271 AWG NO.22

GEARBOX OUTPUT SHAFT

MODEL	SPEC
KEY TYPE	

KEY SPEC

GEARBOX	

WEIGHT

PART	WEIGHT(Kg)
MOTOR	1.6
8GBK3BMH - 8GBK18BMH	0.48
8GBK25BMH - 8GBK30BMH	0.61
8GBK36BMH - 8GBK180BMH	0.67
8GBK200BMH - 8GBK360BMH	0.63
8XD10□□	0.44

32(42.5)-Table1

SIZE(mm)	GEAR RATIO
32	8GBK3BMH - 8GBK18BMH
42.5	8GBK25BMH - 8GBK360BMH

Motor Images

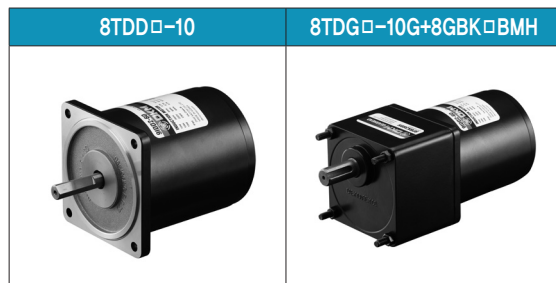

Connection Diagrams

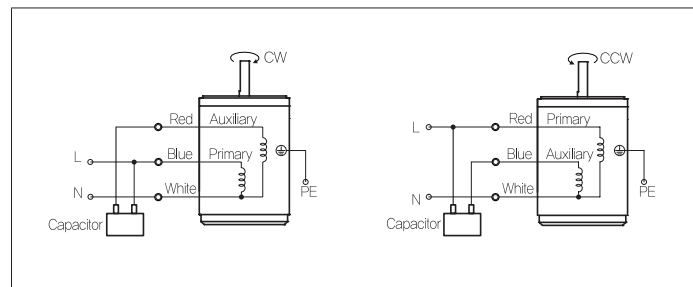

- The direction of motor rotation is as viewed from the shaft end of the motor.
- CW represents the clockwise direction, while CCW represents the counterclockwise direction.
- Change the direction of single phase motor rotation only after bringing the motor to a stop. If an attempt is made to change the direction of rotation while the motor is rotating, the motor may ignore the reversing command or change its direction after some delay.

B AC Motors

Torque Motor 20W(□90mm)

20W Torque Motor 20W(□90mm)

Motor Specification

Model 9TDG□-20F2G: Gear Type Shaft 9TDD□-20F2: D-Cut Type Shaft 9TDK□-20F2: Key Type Shaft	Rating at Locked Rotor	Voltage V	Frequency Hz	Poles	Starting Torque		Output Hz	At max. Output Power				Capacitor μF / VAC	
					kgfcm	N.m		Speed r/min	Torque kgfcm	N.m	Current A		Input W
9TDGA-20F2G	5min.	1∅ 110	60	4	3.00	0.300	20	900	2.20	0.220	1.00	110	16.0 / 250
	Cont.	1∅ 60			0.90	0.090	6		0.65	0.065	0.70	29	
9TDGD-20F2G	5min.	1∅ 220	60	4	3.00	0.300	20		2.20	0.220	0.60	110	4.0 / 450
	Cont.	1∅ 140			0.90	0.090	6		0.65	0.065	0.35	29	
9TDGE-20F2G	5min.	1∅ 220~240	50	4	3.20	0.320	20	750	2.20	0.220	0.60	96	4.0 / 450
	Cont.	1∅ 140			1.00	0.100	6		0.65	0.065	0.35	32	

1) Enter the phase & voltage code in the in the box (□) within the motor model name.

2) All models contain a built-in thermal protector.

3) Gear Type Shaft is for attaching Gearbox and D-Cut & Key Type Shafts are for using motor only.

Max. Permissible Torque at Output Shaft of Gearbox

60Hz

Motor Model	Gearbox Model	Gear Ratio	2	3	3.6	5	6	7.5	9	10	12.5	15	18	25	30	36	40	50	60	75	90	100	120	150	180	200
9TDG□ -20F2G	9GBK□ BMH	5min.	kgfcm 0.36	3.7 0.54	5.5 0.64	6.6 0.89	9.1 1.07	11.0 1.34	13.7 1.61	16.4 1.79	18.3 2.24	22.8 2.68	27.4 2.91	29.7 4.04	41.3 4.85	49.5 5.28	53.9 5.86	59.8 7.33	74.8 8.80	89.8 9.80	100.0 9.80	100.0 9.80	100.0 9.80	100.0 9.80	100.0 9.80	100.0 9.80
		Cont.	kgfcm 0.11	1.1 0.16	1.6 0.19	1.9 0.26	2.7 0.32	3.2 0.40	4.0 0.48	4.9 0.53	5.4 0.66	6.7 0.79	8.1 0.86	8.8 1.19	12.2 1.43	14.6 1.56	15.9 1.73	17.7 2.17	22.1 2.60	26.5 3.25	33.2 3.90	39.8 4.33	44.2 5.20	53.0 6.50	66.3 7.80	79.6 7.80

50Hz

Motor Model	Gearbox Model	Gear Ratio	2	3	3.6	5	6	7.5	9	10	12.5	15	18	25	30	36	40	50	60	75	90	100	120	150	180	200
9TDG□ -20F2G	9GBK□ BMH	5min.	kgfcm 0.36	3.7 0.54	5.5 0.64	6.6 0.89	9.1 1.07	11.0 1.34	13.7 1.61	16.4 1.79	18.3 2.24	22.8 2.68	27.4 2.91	29.7 4.04	41.3 4.85	49.5 5.28	53.9 5.86	59.8 7.33	74.8 8.80	89.8 9.80	100.0 9.80	100.0 9.80	100.0 9.80	100.0 9.80	100.0 9.80	100.0 9.80
		Cont.	kgfcm 0.11	1.1 0.16	1.6 0.19	1.9 0.26	2.7 0.32	3.2 0.40	4.0 0.48	4.9 0.53	5.4 0.66	6.7 0.79	8.1 0.86	8.8 1.19	12.2 1.43	14.6 1.56	15.9 1.73	17.7 2.17	22.1 2.60	26.5 3.25	33.2 3.90	39.8 4.33	44.2 5.20	53.0 6.50	66.3 7.80	79.6 7.80

1) Enter the phase & voltage code in the box (□) within the motor model name.

2) Enter the gear ratio in the box (□) within the Gearbox model name.

3) A colored background indicates gear shaft rotation in the same direction as the motor shaft; a white background indicates rotation in the opposite direction.

4) The rotating speed is calculated by dividing the motor's synchronous speed (50Hz: 1,500r/min, 60Hz: 1,800r/min) by the gear ratio.

The actual speed is 2~20% less than the displayed value, depending on the size of the load.

Dimensions

MOTOR ONLY

- MOTOR MODEL: 9TDD□-20F2 (POWERFUL FAN)

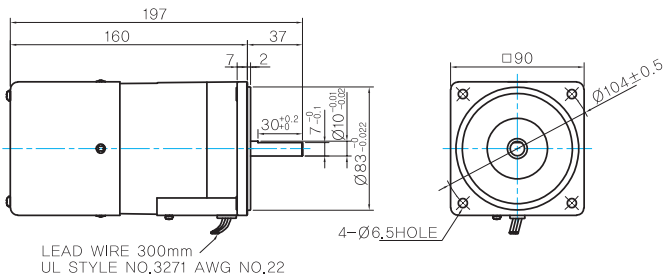

MOTOR OUTPUT SHAFT

MODEL	SPEC
D-CUT TYPE	
9TDD□-20F2	
KEY TYPE	
9TDK□-20F2	

INTER-DECIMAL GEARBOX

- MODEL: 9XD10□□

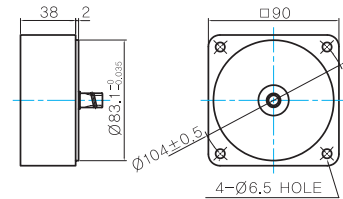

KEY SPEC

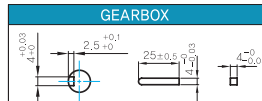

GEARED MOTOR

G TYPE GEARBOX

- MOTOR MODEL: 9TDG□-20F2G (POWERFUL FAN)
- GEARBOX MODEL: 9GBK□BMH

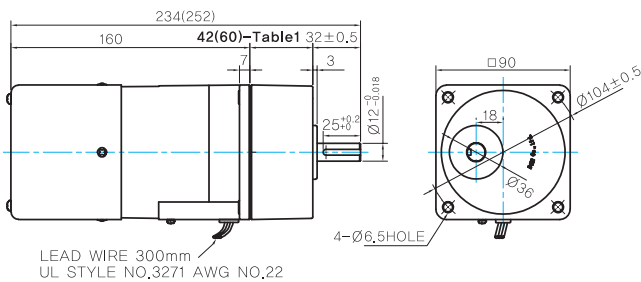

GEARBOX OUTPUT SHAFT

MODEL	SPEC
KEY TYPE	

KEY SPEC

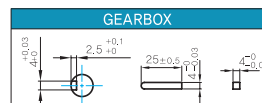

WEIGHT

PART	WEIGHT(Kg)	
MOTOR	2.4	
GEAR BOX	9GBK2BMH ~ 9GBK15BMH	0.67
	9GBK18BMH ~ 9GBK30BMH	0.96
	9GBK36BMH ~ 9GBK200BMH	1.07
	9WD□BL/BR/BRL	1.0
	9XD10□□	0.5

- 42(60)-Table1

SIZE(mm)	GEAR RATIO
42	9GBK2BMH - 9GBK18BMH
60	9GBK25BMH - 9GBK200BMH

Motor Images

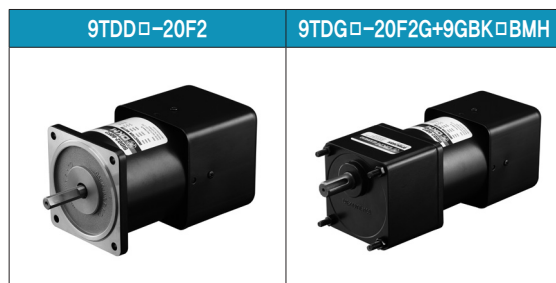

Connection Diagrams

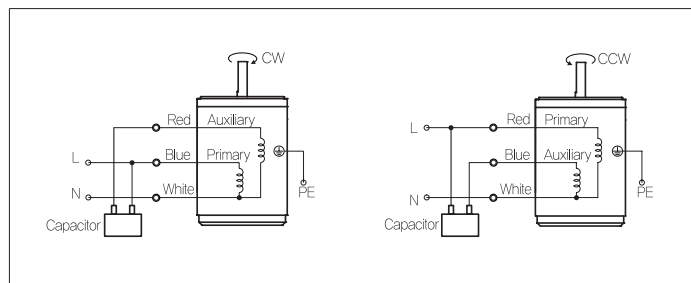

- The direction of motor rotation is as viewed from the shaft end of the motor.
- CW represents the clockwise direction, while CCW represents the counterclockwise direction.
- Change the direction of single phase motor rotation only after bringing the motor to a stop. If an attempt is made to change the direction of rotation while the motor is rotating, the motor may ignore the reversing command or change its direction after some delay.

B AC Motors

Torque Motor 30W(□90mm)

30W Torque Motor 30W(□90mm)

Motor Specification

Model 9TDG*~30F2□: Gear Type Shaft 9TDD*~30F2: D-Cut Type Shaft 9TDK*~30F2: Key Type Shaft	Rating at Locked Rotor	Voltage V	Frequency Hz	Poles	Starting Torque		Output Hz	At max. Output Power				Capacitor μF / VAC	
					kgfcm	N.m		Speed r/min	Torque kgfcm	N.m	Current A		Input W
9TDGA~30F2□	5min.	1φ 110	60	4	4.50	0.450	30	900	3.30	0.330	1.60	150	20.0 / 250
	Cont.	1φ 60			1.50	0.150	12		1.30	0.130	0.90	60	
9TDGD~30F2□	5min.	1φ 220	60	4	4.50	0.450	30		3.30	0.330	0.90	140	5.0 / 450
	Cont.	1φ 140			1.50	0.150	12		1.30	0.130	0.50	50	
9TDGE~30F2□	5min.	1φ 220~240	50	4	4.60	0.460	30	750	3.30	0.330	0.90	140	5.0 / 450
	Cont.	1φ 140			1.60	0.160	12		1.30	0.130	0.50	50	

- 1) Enter the phase & voltage code in the place * and enter the model type of attaching Gearbox in the box (□) within the motor model name.
 2) All models contain a built-in thermal protector. 3) Gear Type Shaft is for attaching Gearbox and D-Cut & Key Type Shafts are for using motor only.

Max. Permissible Torque at Output Shaft of Gearbox

60Hz

Motor Model	Gearbox Model	Gear Ratio	2	3	3.6	5	6	7.5	9	12.5	15	18	20	25	30	36	40	50	60	75	90	100	120	150	180	200	
9TDG□ ~30F2P	9PBK□BH 9PFK□BH	5min.	kgfcm	5.5	8.2	9.9	13.7	16.4	20.5	24.7	30.9	37.1	44.6	44.9	56.1	67.3	80.8	89.8	112.2	134.6	151.0	181.2	200.0	200.0	200.0	200.0	200.0
		N.m	0.54	0.81	0.97	1.34	1.61	2.01	2.42	3.03	3.64	4.37	4.40	5.50	6.60	7.92	8.80	11.00	13.19	14.80	17.75	19.60	19.60	19.60	19.60	19.60	
9TDG□ ~30F2H	9HBK□BH 9HFK□BH	5min.	kgfcm	2.2	3.2	3.9	5.4	6.5	8.1	9.7	12.2	14.6	17.6	17.7	22.1	26.5	31.8	35.4	44.2	53.0	59.5	71.4	79.3	95.2	119.0	142.7	
		N.m	0.21	0.32	0.38	0.53	0.63	0.79	0.95	1.19	1.43	1.72	1.73	2.17	2.60	3.12	3.47	4.33	5.20	5.83	6.99	7.77	9.33	11.66	13.99		
9TDG□ ~30F2H	9HBK□BH 9HFK□BH	5min.	kgfcm	—	8.2	9.9	—	16.4	—	24.7	30.9	37.1	44.6	44.9	56.1	67.3	80.8	—	112.2	134.6	151.0	181.2	201.3	241.6	300.0	300.0	
		N.m	—	0.81	0.97	—	1.61	—	2.42	3.03	3.64	4.37	4.40	5.50	6.60	7.92	—	11.00	13.19	14.80	17.75	19.73	23.67	29.40	29.40		
9TDG□ ~30F2H	9HBK□BH 9HFK□BH	Cont.	kgfcm	—	3.2	3.9	—	6.5	—	9.7	12.2	14.6	17.6	17.7	22.1	26.5	31.8	—	44.2	53.0	59.5	71.4	79.3	95.2	119.0	142.7	
		N.m	—	0.32	0.38	—	0.63	—	0.95	1.19	1.43	1.72	1.73	2.17	2.60	3.12	—	4.33	5.20	5.83	6.99	7.77	9.33	11.66	13.99		

50Hz

Motor Model	Gearbox Model	Gear Ratio	2	3	3.6	5	6	7.5	9	12.5	15	18	20	25	30	36	40	50	60	75	90	100	120	150	180	200
9TDG□ ~30F2P	9PBK□BH 9PFK□BH	5min.	kgfcm	5.5	8.2	9.9	13.7	16.4	20.5	24.7	30.9	37.1	44.6	44.9	56.1	67.3	80.8	89.8	112.2	134.6	151.0	181.2	200.0	200.0	200.0	200.0
		N.m	0.54	0.81	0.97	1.34	1.61	2.01	2.42	3.03	3.64	4.37	4.40	5.50	6.60	7.92	8.80	11.00	13.19	14.80	17.75	19.60	19.60	19.60	19.60	
9TDG□ ~30F2H	9HBK□BH 9HFK□BH	5min.	kgfcm	2.2	3.2	3.9	5.4	6.5	8.1	9.7	12.2	14.6	17.6	17.7	22.1	26.5	31.8	35.4	44.2	53.0	59.5	71.4	79.3	95.2	119.0	142.7
		N.m	0.21	0.32	0.38	0.53	0.63	0.79	0.95	1.19	1.43	1.72	1.73	2.17	2.60	3.12	3.47	4.33	5.20	5.83	6.99	7.77	9.33	11.66	13.99	
9TDG□ ~30F2H	9HBK□BH 9HFK□BH	5min.	kgfcm	—	8.2	9.9	—	16.4	—	24.7	30.9	37.1	44.6	44.9	56.1	67.3	80.8	—	112.2	134.6	151.0	181.2	201.3	241.6	300.0	300.0
		N.m	—	0.81	0.97	—	1.61	—	2.42	3.03	3.64	4.37	4.40	5.50	6.60	7.92	—	11.00	13.19	14.80	17.75	19.73	23.67	29.40	29.40	
9TDG□ ~30F2H	9HBK□BH 9HFK□BH	Cont.	kgfcm	—	3.2	3.9	—	6.5	—	9.7	12.2	14.6	17.6	17.7	22.1	26.5	31.8	—	44.2	53.0	59.5	71.4	79.3	95.2	119.0	142.7
		N.m	—	0.32	0.38	—	0.63	—	0.95	1.19	1.43	1.72	1.73	2.17	2.60	3.12	—	4.33	5.20	5.83	6.99	7.77	9.33	11.66	13.99	

- 1) Enter the phase & voltage code in the box (□) within the motor model name. 2) Enter the gear ratio in the box (□) within the Gearbox model name.
 3) A colored background indicates gear shaft rotation in the same direction as the motor shaft; a white background indicates rotation in the opposite direction.
 4) The rotating speed is calculated by dividing the motor's synchronous speed (50Hz: 1,500r/min, 60Hz: 1,800r/min) by the gear ratio.
 The actual speed is 2~20% less than the displayed value, depending on the size of the load.

Motor Images



Dimensions

MOTOR ONLY

- MOTOR MODEL:
9TDD□-30F2 (POWERFUL FAN)

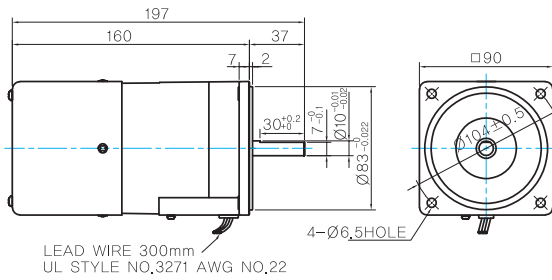

- MOTOR OUTPUT SHAFT
- KEY SPEC

MODEL	SPEC	MOTOR
D-CUT TYPE	37 30±0.2 11±0.05 Ø15±0.08	4+0.03 4±0.03 2.5+0.1 25±0.03 4-0.03
KEY TYPE	37 25±0.03 Ø15±0.08	
9TDD□-30F2		
9TDK□-30F2		

INTER-DECIMAL GEARBOX

- MODEL: 9XD10□□

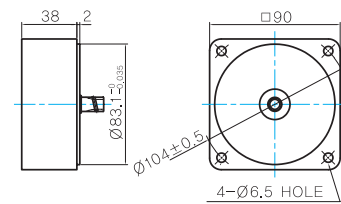

GEARED MOTOR

P TYPE GEARBOX

- MOTOR MODEL:
9TDG□-30F2P (POWERFUL FAN)

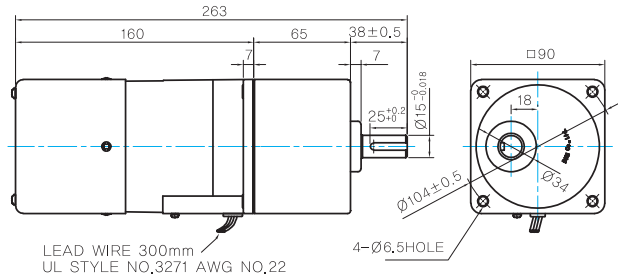

- GEARBOX MODEL:
9PBK□BH

- GEARBOX MODEL:
9PFK□BH

- GEARBOX OUTPUT SHAFT

MODEL	SPEC
KEY TYPE	38 25±0.03 Ø15±0.08
9PBK□BH	
9PFK□BH	

- KEY SPEC

GEARBOX
3+0.1 25±0.03 5-0.03

H TYPE GEARBOX

- MOTOR MODEL:
9TDG□-30F2H (POWERFUL FAN)

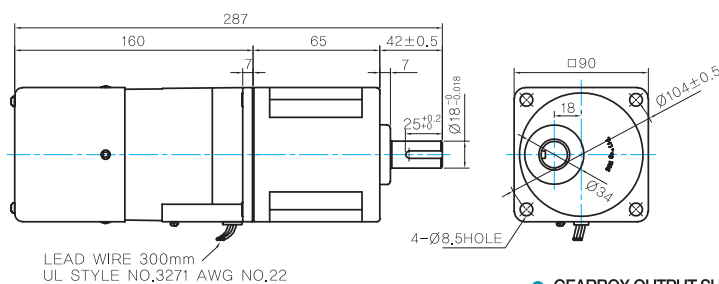

- GEARBOX MODEL:
9HBK□BH

- GEARBOX MODEL:
9HFK□BH

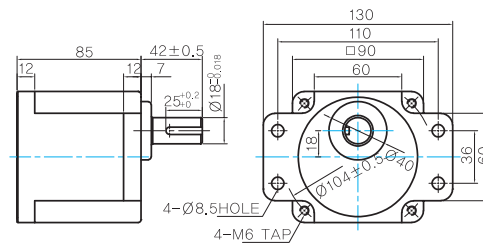

- GEARBOX OUTPUT SHAFT

MODEL	SPEC
KEY TYPE	42 25±0.03 Ø15±0.08
9HBK□BH	
9HFK□BH	

- KEY SPEC

GEARBOX
5+0.03 3+0.1 25±0.03 5-0.03

WEIGHT

PART	WEIGHT(Kg)	
MOTOR	2.7	
GEAR BOX	9PB(F)K2BH ~ 9PB(F)K18BH	1.3
	9PB(F)K20BH ~ 9PB(F)K200BH	1.4
	9HB(F)K3BH ~ 9HB(F)K9BH	1.45
	9HB(F)K12.5BH ~ 9HB(F)K18BH	1.5
	9HB(F)K20BH ~ 9HB(F)K60BH	1.7
	9HB(F)K75BH ~ 9HB(F)K200BH	1.8
	9XD10□□	0.5

Connection Diagrams

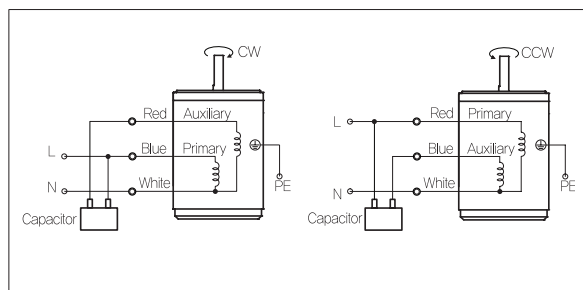

- The direction of motor rotation is as viewed from the shaft end of the motor.
- CW represents the clockwise direction, while CCW represents the counterclockwise direction.
- Change the direction of single phase motor rotation only after bringing the motor to a stop. If an attempt is made to change the direction of rotation while the motor is rotating, the motor may ignore the reversing command or change its direction after some delay.

B AC Motors

Torque Motor 40W(□90mm)

40W Torque Motor 40W(□90mm)

Motor Specification

Model 9TDG*-40F2□: Gear Type Shaft 9TDD*-40F2: D-Cut Type Shaft 9TDK*-40F2: Key Type Shaft	Rating at Locked Rotor	Voltage V	Frequency Hz	Poles	Starting Torque		Output Hz	At max. Output Power				Capacitor μF / VAC	
					kgfcm	N.m		Speed r/min	Torque kgfcm N.m	Current A	Input W		
9TDGA-40F2□	5min.	1φ 110	60	4	6.00	0.600	40	900	4.50	0.450	2.40	200	25.0 / 250
	Cont.	1φ 60			2.00	0.200	17		1.80	0.180	1.60	85	
9TDGD-40F2□	5min.	1φ 220	60	4	6.00	0.600	40	900	4.50	0.450	1.20	200	6.5 / 450
	Cont.	1φ 140			2.00	0.200	17		1.80	0.180	0.80	85	
9TDGE-40F2□	5min.	1φ 220~240	50	4	6.10	0.610	40	750	4.50	0.450	1.20	190	6.5 / 450
	Cont.	1φ 140			2.10	0.210	17		1.80	0.180	0.80	80	

- 1) Enter the phase & voltage code in the place * and enter the model type of attaching Gearbox in the box (□) within the motor model name.
 2) All models contain a built-in thermal protector. 3) Gear Type Shaft is for attaching Gearbox and D-Cut & Key Type Shafts are for using motor only.

Max. Permissible Torque at Output Shaft of Gearbox

60Hz

Motor Model	Gearbox Model	Gear Ratio	2	3	3.6	5	6	7.5	9	12.5	15	18	20	25	30	36	40	50	60	75	90	100	120	150	180	200	
9TDG□ -40F2P	9PBK□BH 9PFK□BH	5min.	kgfcm N.m	7.5 0.73	11.2 1.10	13.4 1.32	18.7 1.83	22.4 2.20	28.0 2.75	33.6 3.29	42.2 4.13	50.6 4.96	60.8 5.95	61.2 6.00	76.5 7.50	91.8 9.00	110.2 10.80	122.4 12.00	153.0 14.99	183.6 17.99	200.0 19.60	200.0 19.60	200.0 19.60	200.0 19.60	200.0 19.60	200.0 19.60	
		Cont.	kgfcm N.m	3.0 0.29	4.5 0.44	5.4 0.53	7.5 0.73	9.0 0.88	11.2 1.10	13.4 1.32	16.9 1.65	20.3 1.98	24.3 2.38	24.5 2.40	30.6 3.00	36.7 3.60	44.1 4.32	49.0 4.80	61.2 6.00	73.4 7.20	82.4 8.07	98.8 9.68	109.8 10.76	131.8 12.91	164.7 16.14	197.6 19.37	197.6 19.37
9TDG□ -40F2H	9HBK□BH 9HFK□BH	5min.	kgfcm N.m	- 1.10	11.2 1.32	13.4 1.32	- 2.20	22.4 2.20	- 3.29	33.6 4.13	42.2 4.96	50.6 5.95	60.8 6.00	61.2 7.50	76.5 9.00	91.8 10.80	110.2 10.80	- 14.99	153.0 17.99	183.6 22.49	200.0 26.99	200.0 29.40	200.0 29.40	200.0 29.40	200.0 29.40	200.0 29.40	200.0 29.40
		Cont.	kgfcm N.m	- 0.44	4.5 0.53	5.4 0.53	- 0.88	9.0 0.88	- 1.32	13.4 1.65	16.9 1.98	20.3 1.98	24.3 2.38	24.5 2.40	30.6 3.00	36.7 3.60	44.1 4.32	49.0 4.80	- 6.00	61.2 7.20	73.4 8.07	82.4 9.68	98.8 10.76	109.8 12.91	131.8 16.14	164.7 19.37	197.6 19.37

50Hz

Motor Model	Gearbox Model	Gear Ratio	2	3	3.6	5	6	7.5	9	12.5	15	18	20	25	30	36	40	50	60	75	90	100	120	150	180	200	
9TDG□ -40F2P	9PBK□BH 9PFK□BH	5min.	kgfcm N.m	7.5 0.73	11.2 1.10	13.4 1.32	18.7 1.83	22.4 2.20	28.0 2.75	33.6 3.29	42.2 4.13	50.6 4.96	60.8 5.95	61.2 6.00	76.5 7.50	91.8 9.00	110.2 10.80	122.4 12.00	153.0 14.99	183.6 17.99	200.0 19.60	200.0 19.60	200.0 19.60	200.0 19.60	200.0 19.60	200.0 19.60	
		Cont.	kgfcm N.m	3.0 0.29	4.5 0.44	5.4 0.53	7.5 0.73	9.0 0.88	11.2 1.10	13.4 1.32	16.9 1.65	20.3 1.98	24.3 2.38	24.5 2.40	30.6 3.00	36.7 3.60	44.1 4.32	49.0 4.80	61.2 6.00	73.4 7.20	82.4 8.07	98.8 9.68	109.8 10.76	131.8 12.91	164.7 16.14	197.6 19.37	197.6 19.37
9TDG□ -40F2H	9HBK□BH 9HFK□BH	5min.	kgfcm N.m	- 1.10	11.2 1.32	13.4 1.32	- 2.20	22.4 2.20	- 3.29	33.6 4.13	42.2 4.96	50.6 5.95	60.8 6.00	61.2 7.50	76.5 9.00	91.8 10.80	110.2 10.80	- 14.99	153.0 17.99	183.6 22.49	200.0 26.99	200.0 29.40	200.0 29.40	200.0 29.40	200.0 29.40	200.0 29.40	200.0 29.40
		Cont.	kgfcm N.m	- 0.44	4.5 0.53	5.4 0.53	- 0.88	9.0 0.88	- 1.32	13.4 1.65	16.9 1.98	20.3 1.98	24.3 2.38	24.5 2.40	30.6 3.00	36.7 3.60	44.1 4.32	49.0 4.80	- 6.00	61.2 7.20	73.4 8.07	82.4 9.68	98.8 10.76	109.8 12.91	131.8 16.14	164.7 19.37	197.6 19.37

- 1) Enter the phase & voltage code in the box (□) within the motor model name. 2) Enter the gear ratio in the box (□) within the Gearbox model name.
 3) A colored background indicates gear shaft rotation in the same direction as the motor shaft; a white background indicates rotation in the opposite direction.
 4) The rotating speed is calculated by dividing the motor's synchronous speed (50Hz: 1,500r/min, 60Hz: 1,800r/min) by the gear ratio.
 The actual speed is 2~20% less than the displayed value, depending on the size of the load.

Motor Images



Dimensions

MOTOR ONLY

- MOTOR MODEL:
9TDD□-40F2 (POWERFUL FAN)
210,5

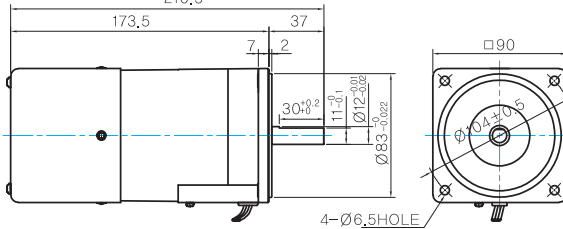

MOTOR OUTPUT SHAFT

MODEL	SPEC
D-CUT TYPE	
KEY TYPE	
9TDD□-40F2	
9TDK□-40F2	

KEY SPEC

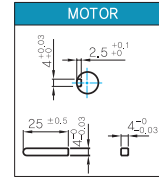

INTER-DECIMAL GEARBOX

- MODEL: 9XD10□□

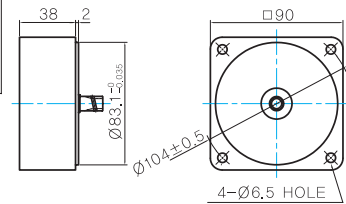

GEARED MOTOR

P TYPE GEARBOX

- MOTOR MODEL:
9TDG□-40F2P (POWERFUL FAN)

- GEARBOX MODEL:
9PBK□BH

- GEARBOX MODEL:
9PFK□BH

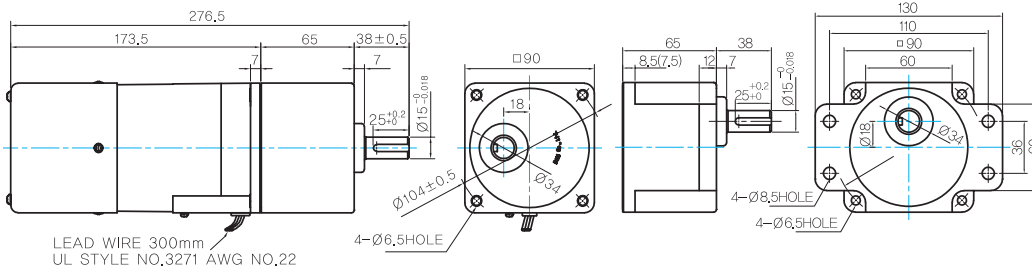

LEAD WIRE 300mm
UL STYLE NO.3271 AWG NO.22

GEARBOX OUTPUT SHAFT

MODEL	SPEC
KEY TYPE	
9PBK□BH	
9PFK□BH	

KEY SPEC

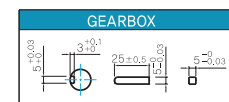

H TYPE GEARBOX

- MOTOR MODEL:
9TDG□-40F2H (POWERFUL FAN)

- GEARBOX MODEL:
9HBK□BH

- GEARBOX MODEL:
9HFK□BH

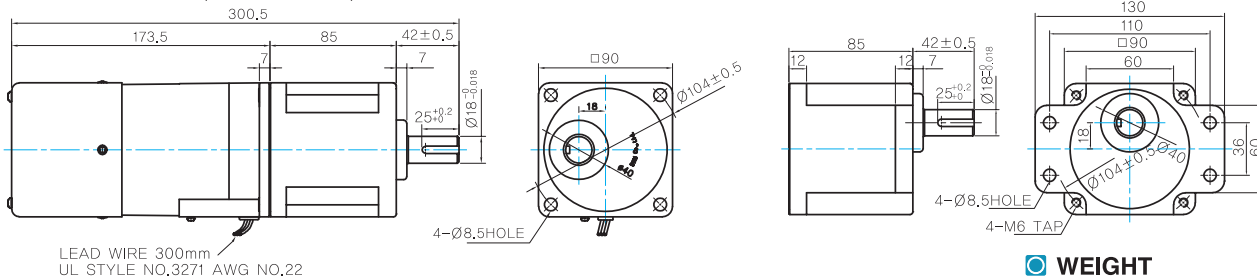

LEAD WIRE 300mm
UL STYLE NO.3271 AWG NO.22

GEARBOX OUTPUT SHAFT

MODEL	SPEC
KEY TYPE	
9HBK□BH	
9HFK□BH	

KEY SPEC

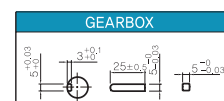

WEIGHT

PART	WEIGHT(Kg)
MOTOR	3,1
9PB(F)K2BH ~ 9PB(F)K18BH	1,3
9PB(F)K20BH ~ 9PB(F)K200BH	1,4
9HB(F)K3BH ~ 9HB(F)K9BH	1,45
9HB(F)K12,5BH ~ 9HB(F)K18BH	1,5
9HB(F)K20BH ~ 9HB(F)K60BH	1,7
9HB(F)K75BH ~ 9HB(F)K200BH	1,8
9XD10□□	0,5

Connection Diagrams

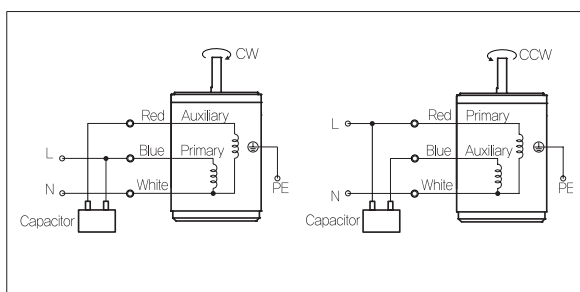

- The direction of motor rotation is as viewed from the shaft end of the motor.
- CW represents the clockwise direction, while CCW represents the counterclockwise direction.
- Change the direction of single phase motor rotation only after bringing the motor to a stop. If an attempt is made to change the direction of rotation while the motor is rotating, the motor may ignore the reversing command or change its direction after some delay